

SLIM MOTOR SERIES

Primado2 Slim Motor
Slim Handpiece 200
Super Slim Handpiece 200
Standard Angled Handpiece 200
Standard Straight Handpiece 200
Perforator / Drill Handpiece 200
Craniotome / Metal Cutting

MICRO BONE SAW SERIES

Reciprocating Saw Handpiece
Sagittal Saw Handpiece
Oscillating Saw Handpiece

FOOT CONTROL

Primado2 Foot Control

WIRE PIN DRIVER SERIES

Primado2 Wire Pin Driver
Wire & Pin Collet
Drill Attachment
Reamer Attachment
Saw Attachment

HIGH TORQUE MOTOR SERIES

Primado2 High Torque Motor
High Speed Handpiece 200
Slim Handpiece
Super Slim Handpiece
Standard Angled Handpiece
Standard Straight Handpiece
Perforator / Craniotome Handpiece
Drill / Contra Angle Handpiece

NSK

CREATE IT.

www.nsk-surgery.com

PR-M0053EN v1 17.10.01 NAM

Feel the difference

Made in Japan, Primado2 is NSK's second generation high speed total surgical system developed to keep up with demand from surgeons.

Since the launch of the first generation of Primado in 2006, we have been working with surgeons across the world. Their needs and requests gave shape to the new Primado2 which we created with balance, power, and a lightweight design to prevent stress from long operating hours.

We invite you to experience Primado2 – the next evolution of high speed drills.

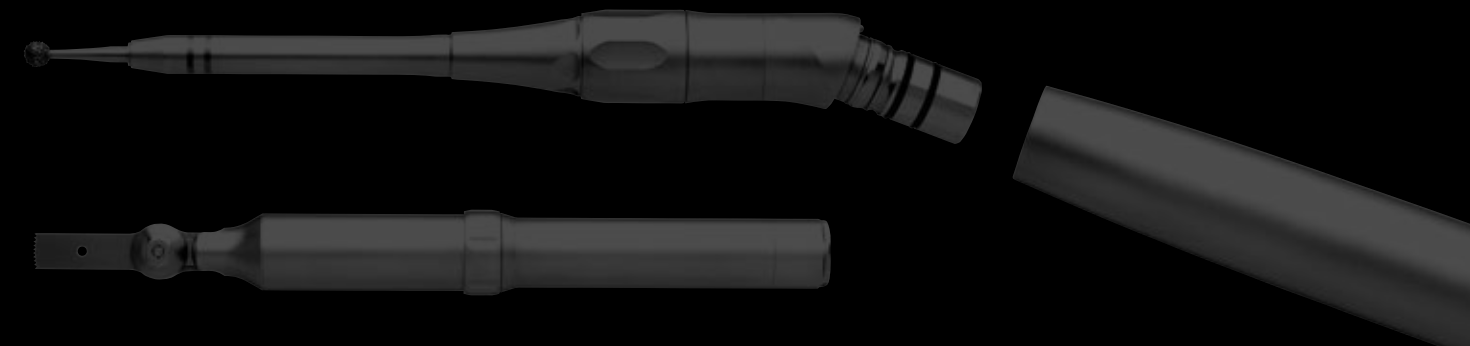

Primado2
Total Surgical System



Primado2 Product Lineup

Primado2 Total Surgical System



Primado2 Control Unit **08**

Slim Motor Series

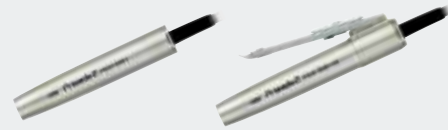

Primado2 Slim Motor **12**



Slim Handpiece 200 **13**



Super Slim Handpiece 200 **14**



Standard Angled Handpiece 200 **15**



Standard Straight Handpiece 200 **16**



Perforator / Drill Handpiece 200 **17**



Craniotome / Metal Cutting **18**

Foot Control

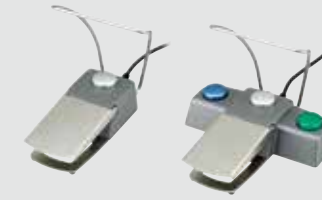

Primado2 Foot Control **10**

High Torque Motor Series



Primado2 High Torque Motor **20**



High Speed Handpiece 200 **21**

Micro Bone Saw Series

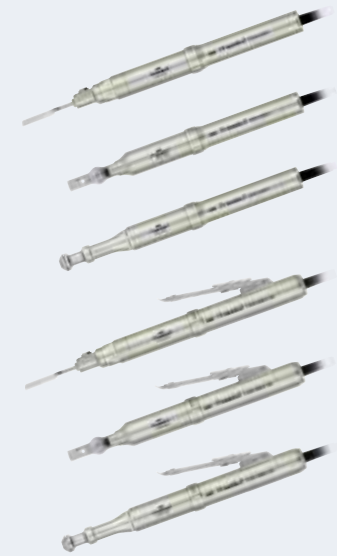

Primado2 Micro Bone Saw **24**

Wire Pin Driver Series



Primado2 Wire Pin Driver **28**



Wire & Pin Collet **29**



Drill Attachment **29**



Reamer Attachment **30**



Saw Attachment **30**

FEEL THE DIFFERENCE

Made in Japan, Primado2 is NSK's second generation high speed total surgical system developed to keep up with demand from surgeons.

Since the launch of the first generation of Primado in 2006, we have been working with surgeons across the world. Their needs and requests gave shape to the new Primado2 which we created with balance, power, and a lightweight design to prevent stress from long operating hours.

We invite you to experience Primado2 – the next evolution of high speed drills.



Primado2 makes it possible

to conduct various types of procedures.

New features include a control unit with LCD display touch screen, a multifunctional foot control, four lineups of motor and extensive attachments. Since all Primado2 motors and handpieces are thermo disinfectant compatible, easy maintenance is achievable.





Primado2 Control Unit

The control unit has a new 6.5 inch LCD screen and a simple design that makes it user friendly.

Two motors can be connected to the unit simultaneously, allowing for quick and easy switching between motors.

order code

P200-CU-120

Primado2 Control Unit for 120V

- Power Supply : AC120V 50/60 Hz
- Dimension : W278 x D268 x H160 (mm)
- Weight : 6.9 kg

Settings

Extensive options are available

Control Unit

- Brightness • Volume
- Language (English, Japanese, German, French, Spanish, Italian)

Motor Handpiece

- Accelerator adjustment (min. 10% - max. 100%)
- Brake adjustment (min. 10% - max. 100%)
- Torque adjustment (min. 30% - max. 100%)
- Oscillation adjustment (1- 5 times, available only for Wire Pin Driver)

Attachment

- Handpiece selection
(Displays rotation speed of engaged handpiece)

Touch Panel

Main Panel

- Speed control
- Irrigation control
- Reverse rotation control
- Priming control

Sub Panel

- Displays the assigned function of each

Mini Panel

- Button for optional settings.

Configuration Settings

The control unit saves the configurations made by the last user except for speed, allowing the surgeons to proceed quickly.

Automatic Recognition for Motors

Four types of motor are automatically recognized by the control unit which displays the corresponding models and rotation speed for each.

Integrated High Performance Irrigation Pump

Primado2 comes equipped with an irrigation pump. Irrigation is adjusted up to a max of 75ml/min.



Primado2 Foot Control

The foot control is available in two models: single (one functional button), and multi (three functional buttons). Each button can be set to a specific function to meet the operator's preference.



Functional Options

<Allocatable Features>

- Foot control ON/OFF
- A ⇌ B control (switching between motors)
- Speed control
(adjust rotational speed; min. 30% ⇒ default ⇒ max. 100%)
- Reverse rotation mode
- Irrigation ON/OFF
- Flush (continuous 100% irrigation when pressed)
- Disable (Set the status as no function)



order code
FC-73

Primado2 Single Foot Control

- 1 pedal with 1 functional button
- Speed control : variable
- IP rating: IPX8



order code
FC-74

Primado2 Multi Foot Control

- 1 pedal with 3 functional buttons
- Speed control : variable
- IP rating: IPX8

Slim Motor Series

- Slim Design** : A compact and lightweight design reduces surgeon fatigue during long operations.
- High Speed** : High speed rotation with a maximum of 80,000min⁻¹ ensures precise cutting.
- Versatile** : Foot control and hand control options available.
- Easy Maintenance** : All motors and handpieces can be processed by a thermo disinfectant.
- Durable** : The Slim Motor Series features a durable design as a result of NSK's long history with high precision technology. The wear-resistant coating contributes to long-lasting and scratch-free products of the high quality.



Primado2 Slim Motor



order code

P200-SMH-HS

Primado2 Slim Motor/HS

- Hand Control type
- Speed: Max. 80,000 min⁻¹
- Available handpieces: 20 types
- Bundled Item: P200-EZ-SM (see p.31)

order code

P200-SMH

Primado2 Slim Motor

- Speed: Max. 80,000 min⁻¹
- Available handpieces: 20 types
- Bundled Item: P200-EZ-SM (see p.31)

Slim Handpiece 200 for $\varnothing 1.0$ mm bur 80,000 min⁻¹

The Slim Handpiece has a 4.8mm diameter bur guard. Various length in curved and straight models that deliver great visualization in endoscopic and minimally invasive spine procedures. The bur guard can be removed with a wrench that is included to provide easy maintenance.

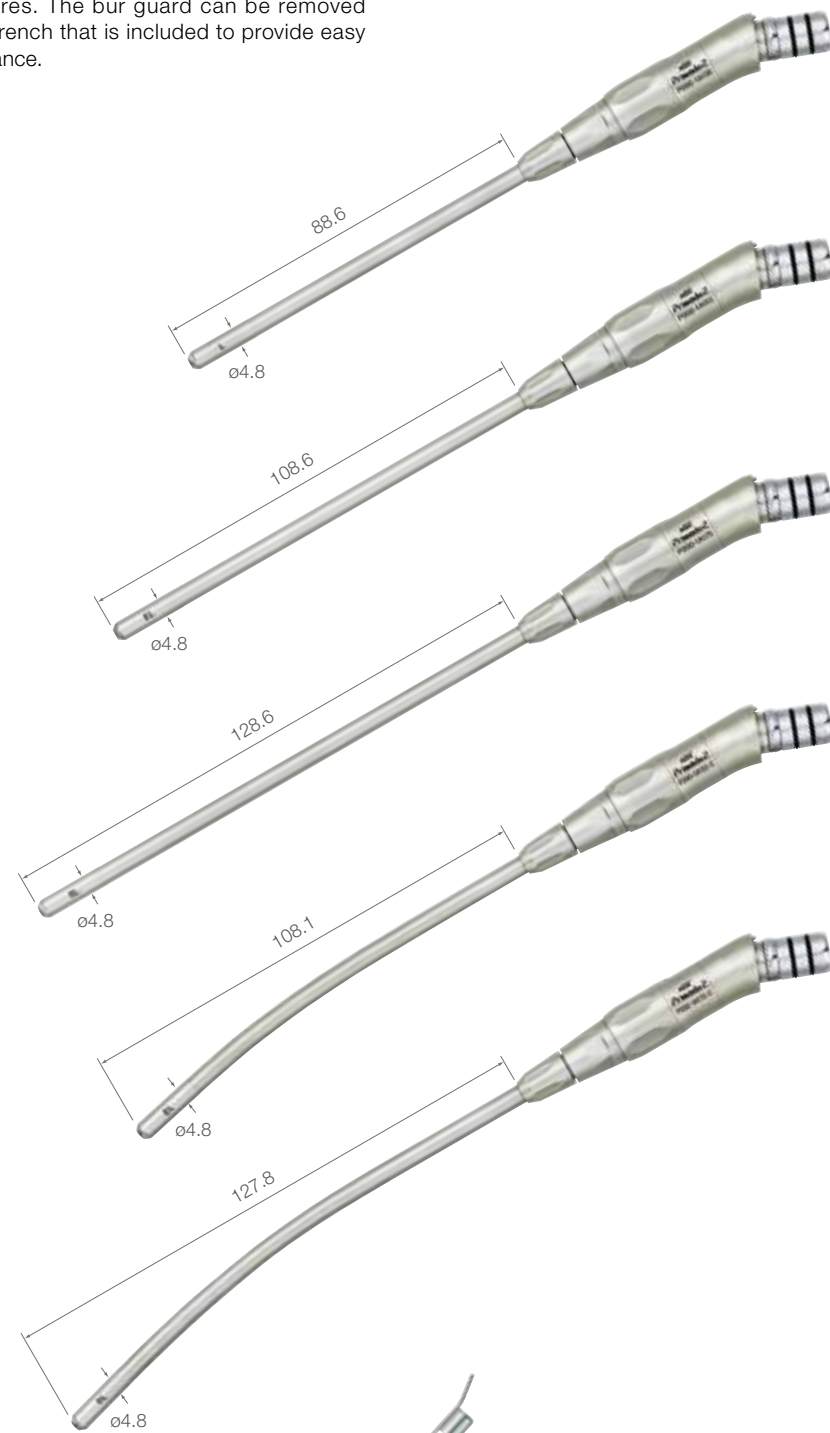

Irrigation Nozzle

order code
P200-IN-1A155
For P200-1A155 (EL)
For P200-1A155-C (EL/Curved)

order code
P200-IN-1A175
For P200-1A175 (SL)
For P200-1A175-C (SL/Curved)



order code

P200-1ARA-W

Wrench for Slim/Super Slim

- Corresponding wrench for bur guard
- Included with Slim Handpiece 200

Super Slim Handpiece 200 for $\varnothing 1.0$ mm bur 20,000 min⁻¹

The Super Slim Handpiece has a 2.1mm diameter bur guard. It is exclusively designed to perform the endoscopic procedure with precise and sensitive drilling of 20,000min⁻¹ at maximum in rotation speed. The bur guard can be removed with a wrench that is included to provide easy maintenance.

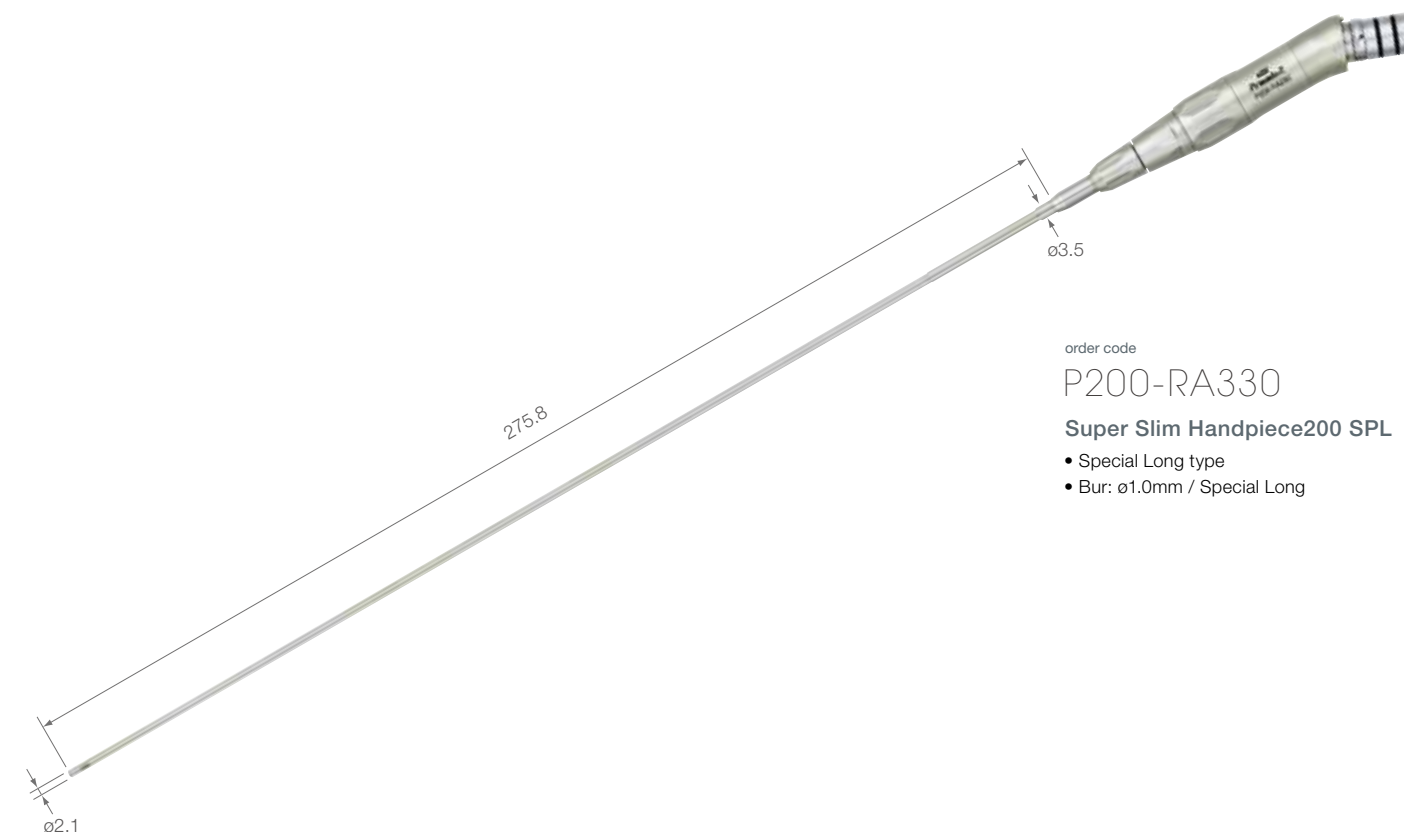

order code

P200-RA330

Super Slim Handpiece200 SPL

- Special Long type
- Bur: $\varnothing 1.0$ mm / Special Long

order code

P200-1ARA-W

Wrench for Slim/Super Slim

- Corresponding wrench for bur guard
- Included with Super Slim Handpiece 200



Standard Angled Handpiece 200 for $\varnothing 2.35$ mm bur 80,000 min⁻¹

Five different lengths of handpieces are available with the Standard Angled Handpiece 200 to address various types of procedures. Consistent rotation and well-balanced ergonomic design relieves fatigue.

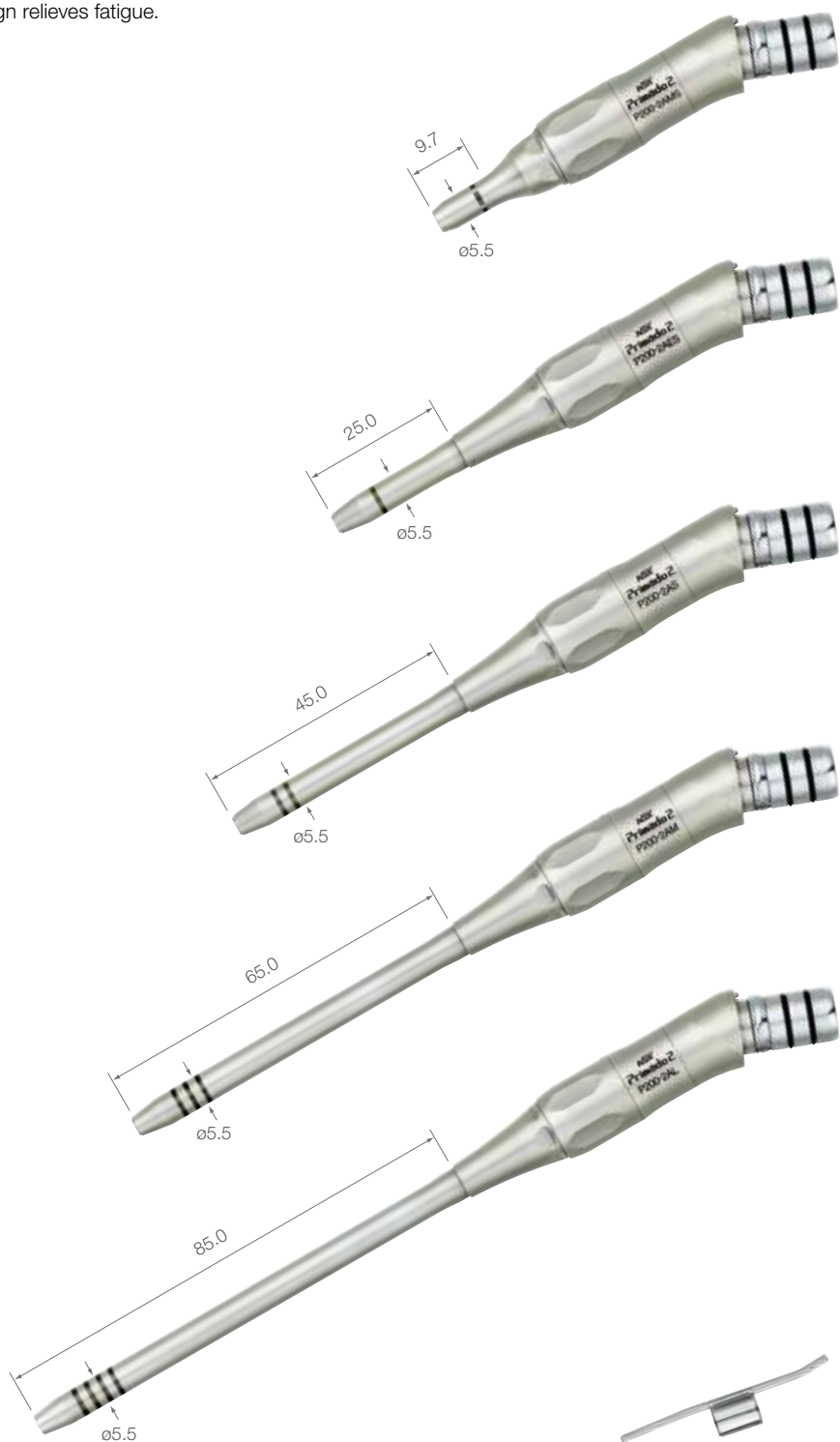

order code

P200-2AMS

Std. Angled Handpiece200 MS

- Mini type
- Bur: $\varnothing 2.35$ mm / MS

order code

P200-2AES

Std. Angled Handpiece200 ES

- Extra Short type
- Bur: $\varnothing 2.35$ mm / Extra Short

order code

P200-2AS

Std. Angled Handpiece200 S

- Short type
- Bur: $\varnothing 2.35$ mm / Short

order code

P200-2AM

Std. Angled Handpiece200 M

- Medium type
- Bur: $\varnothing 2.35$ mm / Medium

order code

P200-2AL

Std. Angled Handpiece200 L

- Long type
- Bur: $\varnothing 2.35$ mm / Long

Irrigation Nozzle

order code

PD-IN-D

For P200-2AMS (MS)

order code

PD-IN-2ES

For P200-2AES (ES)

order code

PD-IN-2S

For P200-2AS (S)

order code

PD-IN-2M

For P200-2AM (M)

order code

PD-IN-2L

For P200-2AL (L)

Standard Straight Handpiece 200 for $\varnothing 2.35$ mm bur 80,000 min⁻¹

Five different lengths of handpieces are available with the Standard Straight Handpiece 200 to address various types of procedures. Consistent rotation and well-balanced ergonomic design relieves fatigue.

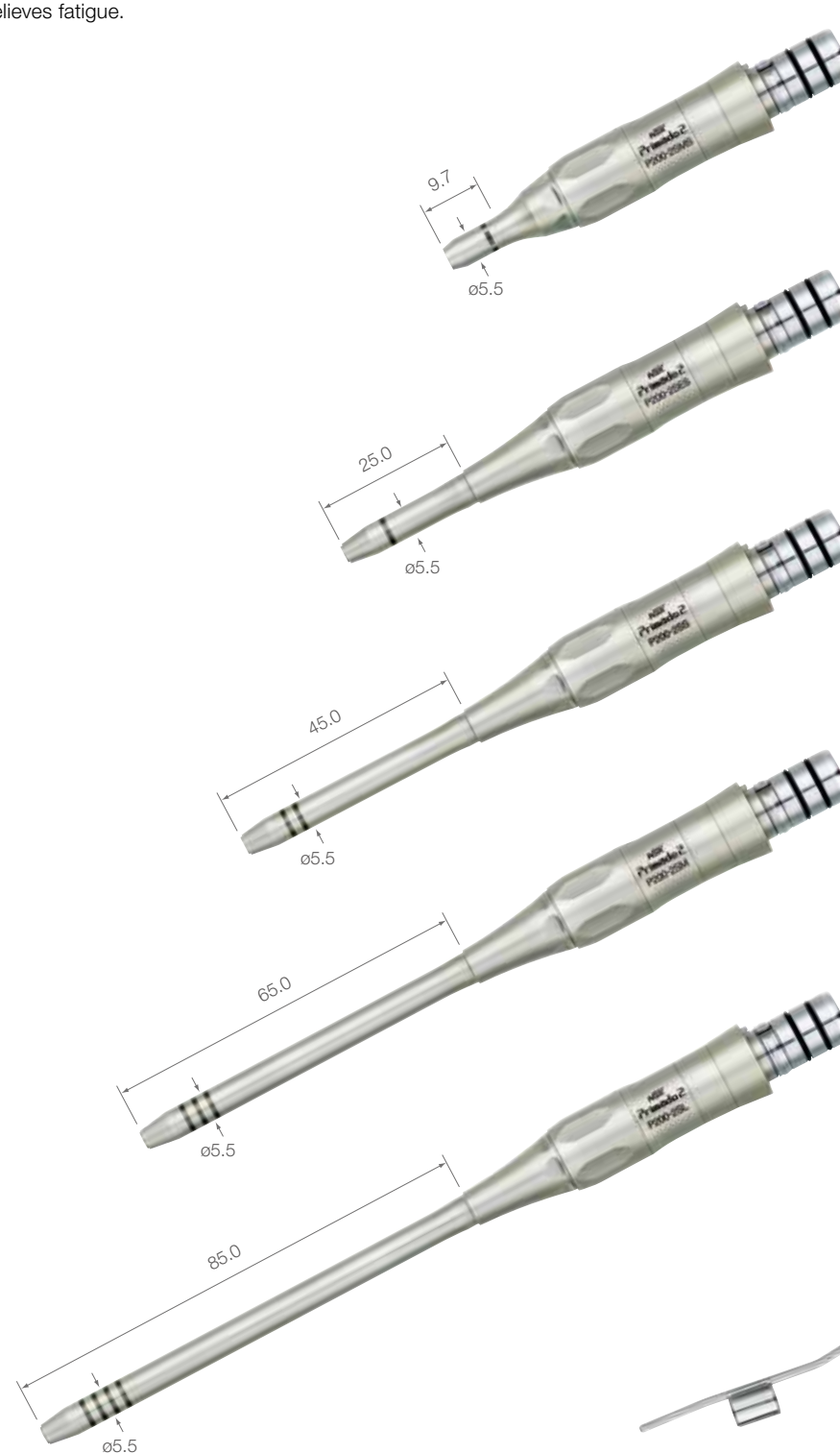

order code

P200-2SMS

Std. Straight Handpiece200 MS

- Mini type
- Bur: $\varnothing 2.35$ mm / MS

order code

P200-2SES

Std. Straight Handpiece200 ES

- Extra Short type
- Bur: $\varnothing 2.35$ mm / Extra Short

order code

P200-2SS

Std. Straight Handpiece200 S

- Short type
- Bur: $\varnothing 2.35$ mm / Short

order code

P200-2SM

Std. Straight Handpiece200 M

- Medium type
- Bur: $\varnothing 2.35$ mm / Medium

order code

P200-2SL

Std. Straight Handpiece200 L

- Long type
- Bur: $\varnothing 2.35$ mm / Long

Irrigation Nozzle

order code

PD-IN-D

For P200-2SMS (MS)

order code

PD-IN-2ES

For P200-2SES (ES)

order code

PD-IN-2S

For P200-2SS (S)

order code

PD-IN-2M

For P200-2SM (M)

order code

PD-IN-2L

For P200-2SL (L)

Perforator Handpiece 200 $1,250 \text{ min}^{-1}$

The perforator handpiece for trephination. It delivers stable torque and achieves smooth and powerful cutting performance.



order code

P200-PER

Perforator Handpiece200

- Compatible Chuck: Hudson Chuck

Drill Handpiece 200 for $\varnothing 2.35 \text{ mm}$ Twist Drill $80,000 \text{ min}^{-1}$

The corresponding handpiece for a trephination.



order code

P200-2SD

Straight Drill Handpiece200

- Bur: $\varnothing 2.35 \text{ mm}$ twist drill



Irrigation Nozzle

order code
PD-IN-D

For P200-2SD

Craniotome Handpiece 200 for $\varnothing 3.17 \text{ mm}$ bur $80,000 \text{ min}^{-1}$

The craniotome handpiece designed for cranial surgery. Three different size of duraguards are available for variable cranial bone thickness from pediatric to adult. Newly offered rotatable duraguard enables smooth and powerful cutting performance contributing to the less fatigue and stress.



order code

P200-CRA

Craniotome Handpiece200

- Bur: Craniotome bur, Router bur



order code

P200-CRD-P

Pediatric Duraguard200

- Bur: Pediatric Craniotome bur
Pediatric Router bur



order code

P200-RCRD-P

Rotatable Duraguard200 P

- Bur: Pediatric Craniotome bur
Pediatric Router bur



order code

P200-CRD-M

Medium Duraguard200

- Bur: Medium Craniotome bur
Medium Router bur



order code

P200-RCRD-M

Rotatable Duraguard200 M

- Bur: Medium Craniotome bur
Medium Router bur



order code

P200-CRD-L

Long Duraguard200

- Bur: Long Craniotome bur
Long Router bur



order code

P200-RCRD-L

Rotatable Duraguard200 L

- Bur: Long Craniotome bur
Long Router bur

Metal Cutting Handpiece 200 for $\varnothing 3.17 \text{ mm}$ bur $80,000 \text{ min}^{-1}$

The corresponding handpiece for cutting implants.



order code

P200-3MC

Metal Cutting Handpiece200

- Bur: Metal Cutting Carbide Bur
Metal Cutting Diamond Disc

High Torque Motor Series

High Torque : High torque motor delivers advanced cutting performance.

Versatile : Foot control and hand control options available

Easy Maintenance : All motors and handpieces can be processed by a thermo disinfecter.

Durable : The High Torque Motor Series features a durable design as a result of NSK's long history with high precision technology. The wear-resistant coating contributes to long-lasting and scratch-free products of the high quality.



Primado2 High Torque Motor



order code

P200-HMH-HS

Primado2 High Torque Motor/HS

- Hand Control type
- Speed: Max. 60,000 min⁻¹
- Available handpieces: 3 types

order code

P200-HMH

Primado2 High Torque Motor

- Speed: Max. 60,000 min⁻¹
- Available handpieces: 3 types

High Speed Handpiece 200 for $\varnothing 3.17$ mm bur 100,000 min⁻¹

The maximum rotational speed of 100,000 min⁻¹ is attained by combining the High Speed Motor with a High Speed Handpiece. Its powerful cutting performance is suitable for open surgery.

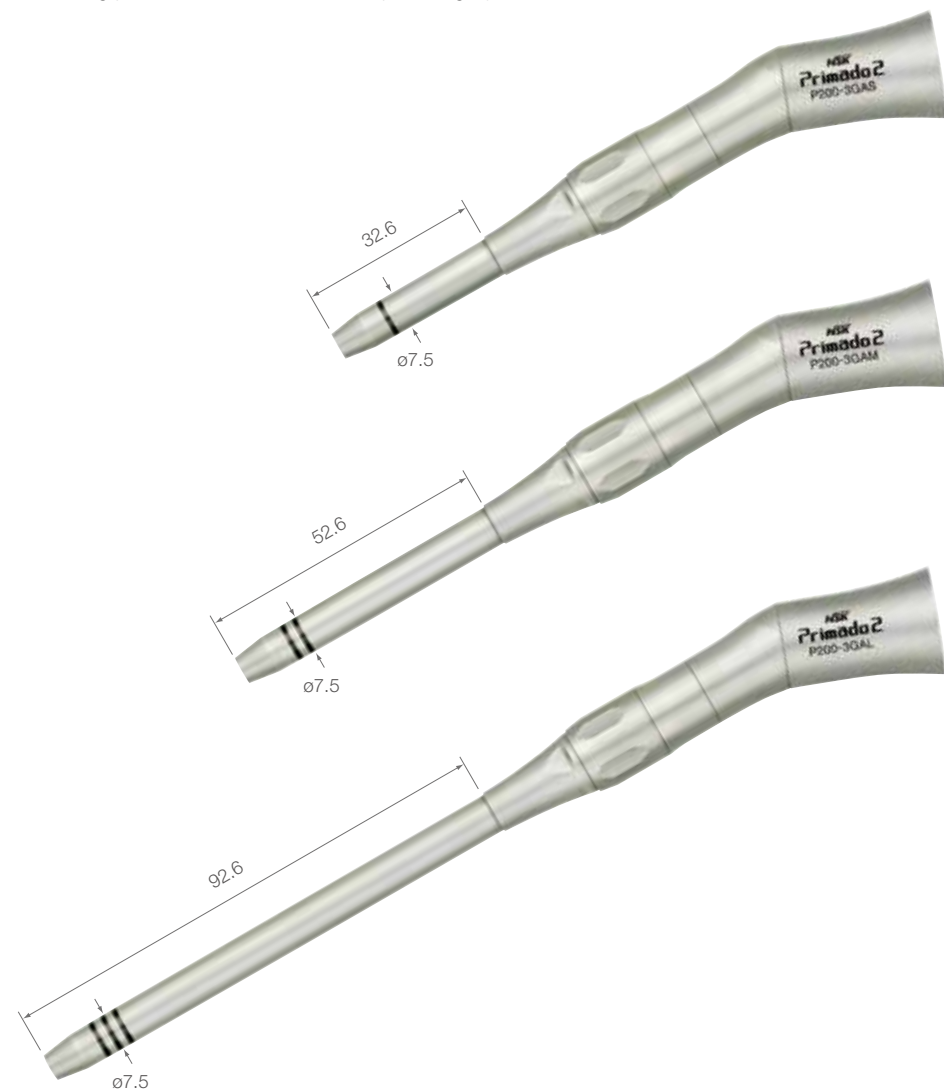

order code

P200-3GAS

High Speed Handpiece200 S

- Short type
- Bur: $\varnothing 3.17$ mm / Short

order code

P200-3GAM

High Speed Handpiece200 M

- Medium type
- Bur: $\varnothing 3.17$ mm / Medium

order code

P200-3GAL

High Speed Handpiece200 L

- Long type
- Bur: $\varnothing 3.17$ mm / Long



Irrigation Nozzle

order code

PD-IN-3S

For P200-3GAS (S)

order code

PD-IN-3M

For P200-3GAM (M)

order code

PD-IN-3L

For P200-3GAL (L)

Micro Bone Saw Series

Slim Design : The streamlined lightweight design delivers well-balanced handling.

High Performance : Consistent cutting performance paired with low rotational vibration creates smooth operation.

Easy Maintenance : All motors and handpieces can be processed by a thermo disinfectant.

Durable : The Micro Bone Saw Series features a durable design as a result of NSK's long history with high precision technology. The wear-resistant coating contributes to long-lasting and scratch-free products of the highest quality.



Reciprocating
Saw Handpiece



Sagittal
Saw Handpiece



Oscillating
Saw Handpiece

Primado2 Reciprocating Saw Handpiece 20,000 min⁻¹



order code

P200-REC-S

Primado2 Rec. Handpiece

- Speed: Max. 20,000 min⁻¹
- Stroke Length: 2.5 mm
- Blade: Reciprocating Saw Blades, Reciprocating Rasps
- Bundled Item: P200-EZ-BM (see p.31)



order code

P200-REC-S-HS

Primado2 Rec. Handpiece/HS

- Hand Control type
- Speed: Max. 20,000 min⁻¹
- Stroke Length: 2.5 mm
- Blade: Reciprocating Saw Blades, Reciprocating Rasps
- Bundled Item: P200-EZ-BM (see p.31)



Irrigation Nozzle

order code

P200-IN-BS

For P200-REC-S, P200-REC-S-HS

Primado2 Sagittal Saw Handpiece 20,000 min⁻¹



order code
P200-SAG-S

Primado2 Sag. Handpiece

- Speed: Max. 20,000 min⁻¹
- Angle of Oscillation: 8°
- Blade: Sagittal and Oscillating Saw Blades
- Bundled Item: P200-EZ-BM (see p.31)



order code
P200-SAG-S-HS

Primado2 Sag. Handpiece/HS

- Hand Control type
- Speed: Max. 20,000 min⁻¹
- Angle of Oscillation: 8°
- Blade: Sagittal and Oscillating Saw Blades
- Bundled Item: P200-EZ-BM (see p.31)



Irrigation Nozzle

order code
P200-IN-BS
For P200-SAG-S, P200-SAG-S-HS

Primado2 Oscillating Saw Handpiece 20,000 min⁻¹



order code
P200-OSC-S

Primado2 Osc. Handpiece

- Speed: Max. 20,000 min⁻¹
- Angle of Oscillation: 8°
- Blade: Sagittal and Oscillation Saw Blades, Oscillating Saw Blades (for Intra Oral)
- Bundled Item: P200-EZ-BM (see p.31)



order code
P200-OSC-S-HS

Primado2 Osc. Handpiece/HS

- Hand Control type
- Speed: Max. 20,000 min⁻¹
- Angle of Oscillation: 8°
- Blade: Sagittal and Oscillation Saw Blades, Oscillating Saw Blades (for Intra Oral)
- Bundled Item: P200-EZ-BM (see p.31)



order code
PD-OSC-A

Adaptor

- Blade: Oscillating Saw Blades (for Intra Oral)
- Bundled Item: Corresponding wrench(1), and screws (2)



Irrigation Nozzle

order code
P200-IN-BS
For P200-OSC-S, P200-OSC-S-HS

Wire Pin Driver Series

Powerful : Delivers powerful pinning, wiring, and drilling through elaborate design.

Ergonomic Design : Smart design fits comfortably in the surgeon's hand and creates smooth handling and high operability.

Easy Maintenance : All motors and handpieces can be processed by a thermo disinfectant.



Wire & Pin Collet



Drill Attachment



Reamer Attachment



Saw Attachment

Primado2 Wire Pin Driver



order code

P200-WPD

Primado2 Wire Pin Driver

- Speed : Max. 1,200 min⁻¹
- Rotation Mode: Forward, Reverse, Oscillating
- Bundled Item: P200-EZ-WPD (see p.31)

Attachment for Wire Pin Driver

Wire & Pin Collet 1,200 min⁻¹



order code
PD-DA-W
Primado Wire Collet
• ø0.6-ø1.9 mm



order code
PD-DA-P
Primado Pin Collet
• ø2.0-ø3.2 mm

Drill Attachment 1,200 min⁻¹



order code
PD-DA-J4
Jacobs Keyed Drill Chuck
• ø0.5-ø4.0 mm
• Bundled Item: T wrench



order code
PD-DA-J6
Jacobs Keyed Drill Chuck
• ø0.5-ø6.5 mm
• Bundled Item: T wrench



order code
PD-DA-A
AO Drill Chuck



order code
PD-DA-K
Keyless Drill Chuck
• ø0.6-ø7.4 mm

order code
PD-TW-J4
T wrench



order code
PD-TW-J6
T wrench



Attachment for Wire Pin Driver

Reamer Attachment 300 min⁻¹



order code
PD-RA-M
**Hudson Modified
Trinkle Reamer**



order code
PD-RA-H
Hudson Reamer



order code
PD-RA-T
Trinkle Reamer



order code
PD-RA-A
AO Reamer

Saw Attachment 12,000 min⁻¹



order code
PD-SA-R
Reciprocating Saw Attachment
• Blade: Reciprocating Saw Blades,
Reciprocating Rasps



order code
PD-SA-S
Sagittal Saw Attachment
• Blade: Sagittal and Oscillating Saw Blades

Maintenance

PANA SPRAY Plus is a specially formulated, highly effective general handpiece lubricant. Lubricating with PANA SPRAY Plus will ensure handpiece performance and durability. Apply PANA SPRAY Plus to handpieces after "Cleaning" in the maintenance process.



order code
Z182600
PANA Spray Plus

- For Handpieces, 480 mL
- Alcohol-contained Lubricant

order code
Y1002906
PANA Spray Plus (6pcs)

- Pack of 6

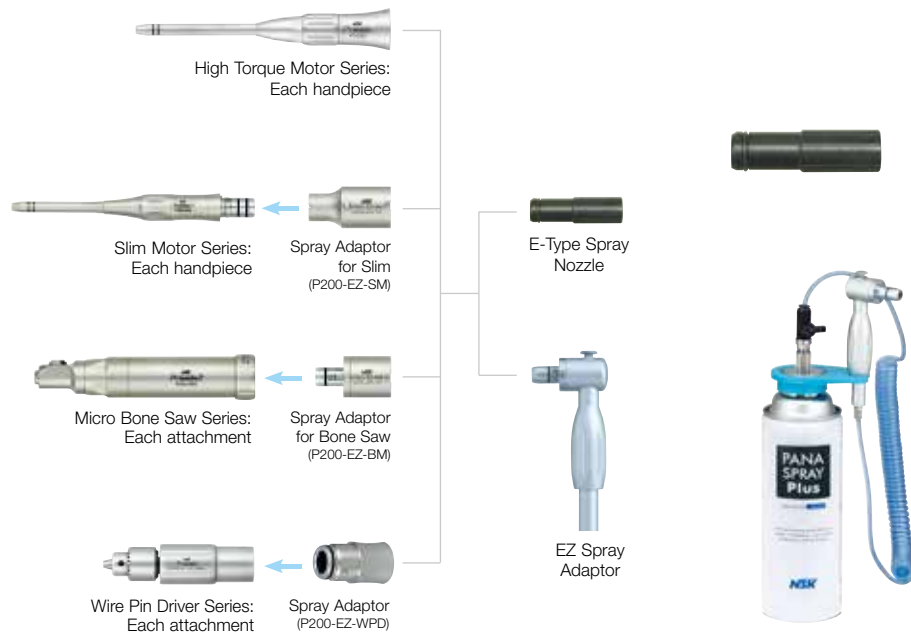

order code
Z019090
E-Type Spray Nozzle

- For Handpieces

order code
PD-EZ-M
EZ Spray Adaptor

- PANA Spray Plus is not included

Spray Mist Absorber

A convenient way to avoid mist spray from escaping into the environment. Simply insert the handpiece into the Absorber Pack then apply the spray lubricant.



order code
Y900084
Spray Mist Absorber

- Pack of 10

Mobile Trolley

NSK offers a specially designed mobile trolley for the Primado control unit which is not only practical but also elegant. In this way, all the equipment can be stored in one place allowing easy access when needed. The trolley has adjustable height, lockable wheels and a bracket for the cable on the side.



order code
Z299
iCart-L Mobile Trolley

- Dimensions : W360 x D420 x H800 (mm)
- Weight : 10 kg

Irrigation Tube



order code
PD-IT-S
Surgical Irrigation Tube

- Pack of 10 (Sterilized)

Memo

Manufacturer

NAKANISHI INC. www.nsk-surgery.com
700 Shimohinata, Kanuma, Tochigi 322-8666, Japan
TEL : +81 (0)289-64-3380 FAX : +81 (0)289-64-3890

NSK America Corp
1800 Global Parkway, Hoffman Estates, IL 60192, USA
TEL : +1 888 675 1675 FAX : +1 800 838 9328

Specifications are subject to change without notice.



ROTARY INSTRUMENTS

SAW BLADES

INTRA ORAL BLADES

RASPS



CREATE IT.

Feel the difference

Made in Japan, Primado2 is NSK's second generation high speed total surgical system developed to keep up with demand from surgeons.

Since the launch of the first generation of Primado in 2006, we have been working with surgeons across the world. Their needs and requests gave shape to the new Primado2 which we created with balance, power, and a lightweight design to prevent stress from long operating hours.

We invite you to experience Primado2 – the next evolution of high speed drills.

Primado

— series —

CUTTING ACCESSORIES

Feel the difference

Made in Japan, Primado2 is NSK's second generation high speed total surgical system developed to keep up with demand from surgeons.

Since the launch of the first generation of Primado in 2006, we have been working with surgeons across the world. Their needs and requests gave shape to the new Primado2 which we created with balance, power, and a lightweight design to prevent stress from long operating hours.

We invite you to experience Primado2 – the next evolution of high speed drills.



ROTARY INSTRUMENTS $\varnothing 1.0 \text{ mm}$

Diamond Burs

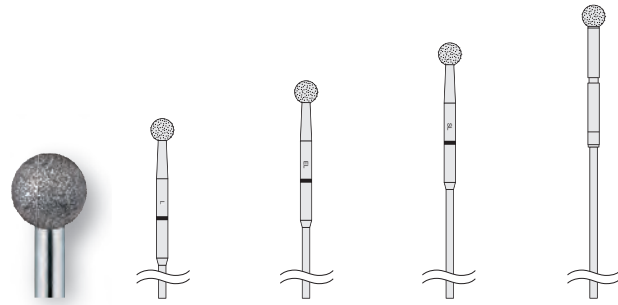

Head Size	Long	Extra Long	Super Long	Special Long
	for P200-1A135 PD-1A135	for P200-1A155 P200-1A155-C PD-1A155-10	for P200-1A175 P200-1A175-C PD-1A175-10	for P200-RA330 PD-RA330
2.0	PDS-1D135-20	PDS-1D155-20	PDS-1D175-20	PDS-1D330-20
2.5	—	—	—	PDS-1D330-25
3.0	PDS-1D135-30	PDS-1D155-30	PDS-1D175-30	PDS-1D330-30
3.5	—	—	—	PDS-1D330-35
4.0	PDS-1D135-40	PDS-1D155-40	PDS-1D175-40	—

Coarse Diamond Burs

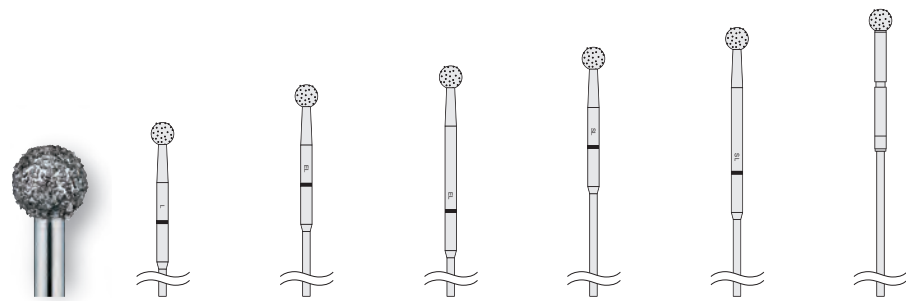

Head Size	Long	Extra Long	Extra Long [Extended]	Super Long	Super Long [Extended]	Special Long
	for P200-1A135 PD-1A135	for P200-1A155 P200-1A155-C PD-1A155-10	for P200-1A155 P200-1A155-C PD-1A155-10	for P200-1A175 P200-1A175-C PD-1A175-10	for P200-1A175 P200-1A175-C PD-1A175-10	for P200-RA330 PD-RA330
2.0	PDS-1CD135-20	PDS-1CD155-20	PDS-1CD155-20E	PDS-1CD175-20	PDS-1CD175-20E	PDS-1CD330-20
2.5	—	—	—	—	—	PDS-1CD330-25
3.0	PDS-1CD135-30	PDS-1CD155-30	PDS-1CD155-30E	PDS-1CD175-30	PDS-1CD175-30E	PDS-1CD330-30
3.5	—	—	—	—	—	PDS-1CD330-35
4.0	PDS-1CD135-40	PDS-1CD155-40	—	PDS-1CD175-40	—	—

Extended bur: Burs can be extended by 6 mm from the original length.



ROTARY INSTRUMENTS $\varnothing 1.0 \text{ mm}$

Neuro Diamond Burs

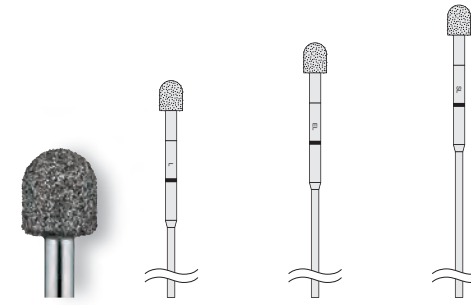

Head Size	Long	Extra Long	Super Long
	for P200-1A135 PD-1A135	for P200-1A155 P200-1A155-C PD-1A155-10	for P200-1A175 P200-1A175-C PD-1A175-10
2.0	PDS-1ND135-20	PDS-1ND155-20	PDS-1ND175-20
3.0	PDS-1ND135-30	PDS-1ND155-30	PDS-1ND175-30
4.0	PDS-1ND135-40	PDS-1ND155-40	PDS-1ND175-40

Neuro Coarse Diamond Burs

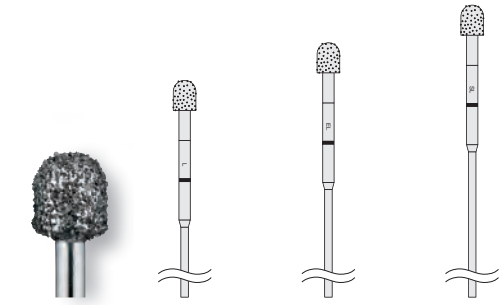

Head Size	Long	Extra Long	Super Long
	for P200-1A135 PD-1A135	for P200-1A155 P200-1A155-C PD-1A155-10	for P200-1A175 P200-1A175-C PD-1A175-10
2.0	PDS-1NCD135-20	PDS-1NCD155-20	PDS-1NCD175-20
3.0	PDS-1NCD135-30	PDS-1NCD155-30	PDS-1NCD175-30
4.0	PDS-1NCD135-40	PDS-1NCD155-40	PDS-1NCD175-40

Round Fluted Burs



Head Size	Extra Long	Super Long
	for P200-1A155 P200-1A155-C PD-1A155-10	for P200-1A175 P200-1A175-C PD-1A175-10
2.0	PDS-1C155-20	PDS-1C175-20
3.0	PDS-1C155-30	PDS-1C175-30
4.0	PDS-1C155-40	PDS-1C175-40

MH Cutting Burs



Head Size	Extra Long	Super Long
	for P200-1A155 P200-1A155-C PD-1A155-10	for P200-1A175 P200-1A175-C PD-1A175-10
2.5	PDS-1MHC155-25	PDS-1MHC175-25
3.0	PDS-1MHC155-30	PDS-1MHC175-30



ROTARY INSTRUMENTS $\varnothing 2.35$ mm

Round Fluted Burs

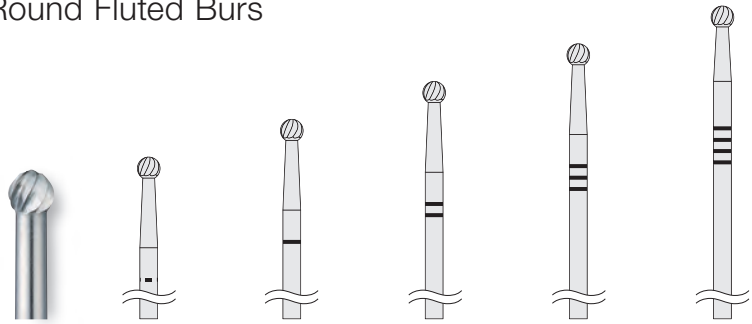

Head Size	MS	Extra Short	Short	Medium	Long
	for P200-2AMS P200-2SMS	for P200-2AES P200-2SES PD-2AES PD-2SES	for P200-2AS P200-2SS PD-2AS PD-2SS	for P200-2AM P200-2SM PD-2AM PD-2SM	for P200-2AL P200-2SL PD-2AL
1.0	PDS-2CMS-10	PDS-2CES-10	PDS-2CS-10	PDS-2CM-10	—
2.0	PDS-2CMS-20	PDS-2CES-20	PDS-2CS-20	PDS-2CM-20	PDS-2CL-20
3.0	PDS-2CMS-30	PDS-2CES-30	PDS-2CS-30	PDS-2CM-30	PDS-2CL-30
4.0	PDS-2CMS-40	PDS-2CES-40	PDS-2CS-40	PDS-2CM-40	PDS-2CL-40
5.0	PDS-2CMS-50	PDS-2CES-50	PDS-2CS-50	PDS-2CM-50	PDS-2CL-50
6.0	PDS-2CMS-60	PDS-2CES-60	PDS-2CS-60	PDS-2CM-60	PDS-2CL-60
7.0	PDS-2CMS-70	PDS-2CES-70	PDS-2CS-70	PDS-2CM-70	PDS-2CL-70

Carbide Burs

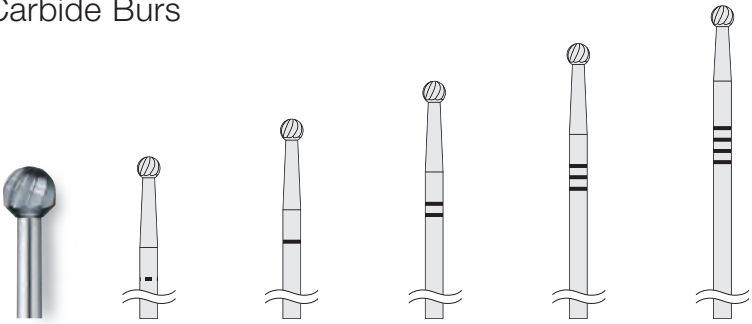

Head Size	MS	Extra Short	Short	Medium	Long
	for P200-2AMS P200-2SMS	for P200-2AES P200-2SES PD-2AES PD-2SES	for P200-2AS P200-2SS PD-2AS PD-2SS	for P200-2AM P200-2SM PD-2AM PD-2SM	for P200-2AL P200-2SL PD-2AL
2.0	PDS-2CBMS-20	PDS-2CBES-20	PDS-2CBS-20	PDS-2CBM-20	PDS-2CBL-20
3.0	PDS-2CBMS-30	PDS-2CBES-30	PDS-2CBS-30	PDS-2CBM-30	PDS-2CBL-30
4.0	PDS-2CBMS-40	PDS-2CBES-40	PDS-2CBS-40	PDS-2CBM-40	PDS-2CBL-40
5.0	PDS-2CBMS-50	PDS-2CBES-50	PDS-2CBS-50	PDS-2CBM-50	PDS-2CBL-50
6.0	PDS-2CBMS-60	PDS-2CBES-60	PDS-2CBS-60	PDS-2CBM-60	PDS-2CBL-60
7.0	PDS-2CBMS-70	PDS-2CBES-70	PDS-2CBS-70	PDS-2CBM-70	PDS-2CBL-70

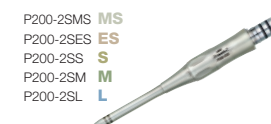
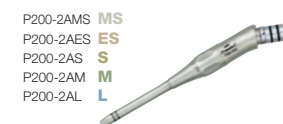
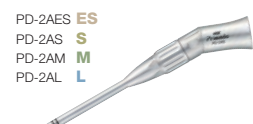
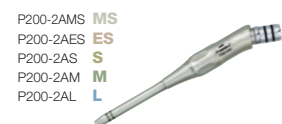

ROTARY INSTRUMENTS $\varnothing 2.35$ mm

Diamond Burs

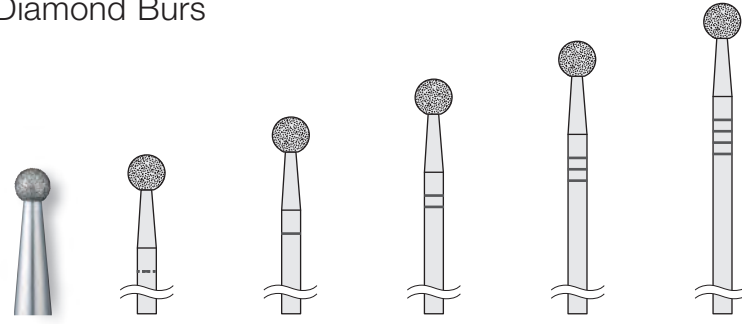

Head Size	MS	Extra Short	Short	Medium	Long
	for P200-2AMS P200-2SMS	for P200-2AES P200-2SES PD-2AES PD-2SES	for P200-2AS P200-2SS PD-2AS PD-2SS	for P200-2AM P200-2SM PD-2AM PD-2SM	for P200-2AL P200-2SL PD-2AL
0.6	PDS-2DMS-06	PDS-2DES-06	PDS-2DS-06	—	—
1.0	PDS-2DMS-10	PDS-2DES-10	PDS-2DS-10	PDS-2DM-10	—
1.5	PDS-2DMS-15	PDS-2DES-15	PDS-2DS-15	—	—
2.0	PDS-2DMS-20	PDS-2DES-20	PDS-2DS-20	PDS-2DM-20	PDS-2DL-20
3.0	PDS-2DMS-30	PDS-2DES-30	PDS-2DS-30	PDS-2DM-30	PDS-2DL-30
4.0	PDS-2DMS-40	PDS-2DES-40	PDS-2DS-40	PDS-2DM-40	PDS-2DL-40
5.0	PDS-2DMS-50	PDS-2DES-50	PDS-2DS-50	PDS-2DM-50	PDS-2DL-50
6.0	PDS-2DMS-60	PDS-2DES-60	PDS-2DS-60	PDS-2DM-60	PDS-2DL-60
7.0	PDS-2DMS-70	PDS-2DES-70	PDS-2DS-70	PDS-2DM-70	PDS-2DL-70

ROTARY INSTRUMENTS $\varnothing 2.35$ mm

Coarse Diamond Burs

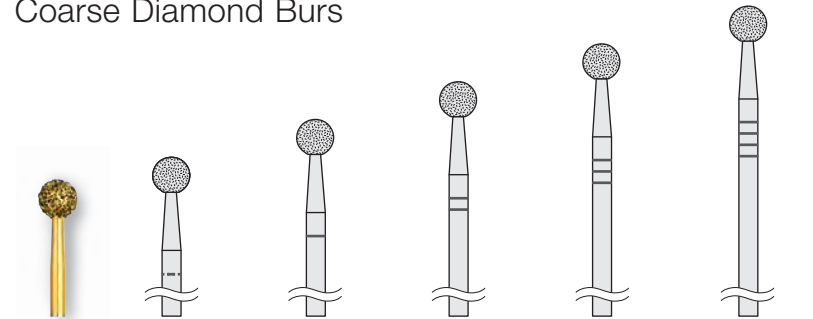

Head Size	MS for P200-2AMS P200-2SMS	Extra Short for P200-2AES P200-2SES PD-2AES PD-2SES	Short for P200-2AS P200-2SS PD-2AS PD-2SS	Medium for P200-2AM P200-2SM PD-2AM PD-2SM	Long for P200-2AL P200-2SL PD-2AL
1.0	PDS-2CDMS-10	PDS-2CDES-10	PDS-2CDS-10	—	—
1.5	PDS-2CDMS-15	PDS-2CDES-15	PDS-2CDS-15	—	—
2.0	PDS-2CDMS-20	PDS-2CDES-20	PDS-2CDS-20	PDS-2CDM-20	PDS-2CDL-20
3.0	PDS-2CDMS-30	PDS-2CDES-30	PDS-2CDS-30	PDS-2CDM-30	PDS-2CDL-30
4.0	PDS-2CDMS-40	PDS-2CDES-40	PDS-2CDS-40	PDS-2CDM-40	PDS-2CDL-40
5.0	PDS-2CDMS-50	PDS-2CDES-50	PDS-2CDS-50	PDS-2CDM-50	PDS-2CDL-50
6.0	PDS-2CDMS-60	PDS-2CDES-60	PDS-2CDS-60	PDS-2CDM-60	PDS-2CDL-60
7.0	PDS-2CDMS-70	PDS-2CDES-70	PDS-2CDS-70	PDS-2CDM-70	PDS-2CDL-70

Coarse Diamond Burs / Extended

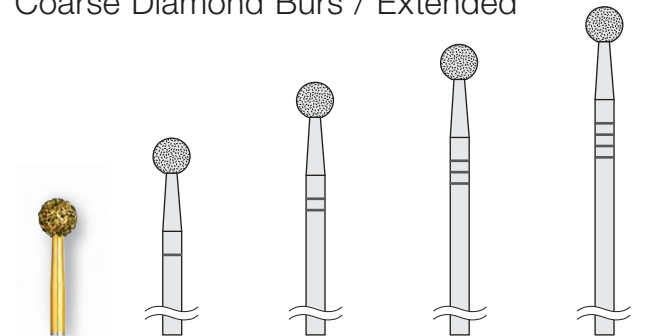

Head Size	Extra Short	Short [Extended]	Medium [Extended]	Long [Extended]
	for P200-2AES P200-2SES PD-2AES PD-2SES	for P200-2AS P200-2SS PD-2AS PD-2SS	for P200-2AM P200-2SM PD-2AM PD-2SM	for P200-2AL P200-2SL PD-2AL
1.0	PDS-2CDEMS-10E	—	—	—
1.5	PDS-2CDEMS-15E	—	—	—
2.0	—	PDS-2CDS-20E	PDS-2CDM-20E	PDS-2CDL-20E
3.0	—	PDS-2CDS-30E	PDS-2CDM-30E	PDS-2CDL-30E
4.0	—	PDS-2CDS-40E	PDS-2CDM-40E	PDS-2CDL-40E
5.0	—	PDS-2CDS-50E	PDS-2CDM-50E	PDS-2CDL-50E

Extended bur: Burs can be extended by 10 mm from the original length.



ROTARY INSTRUMENTS $\varnothing 2.35$ mm

Extra Coarse Diamond Burs

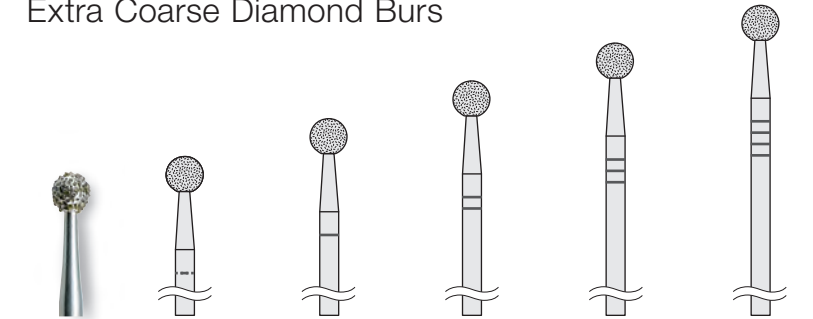

Head Size	MS for P200-2AMS P200-2SMS	Extra Short for P200-2AES P200-2SES PD-2AES PD-2SES	Short for P200-2AS P200-2SS PD-2AS PD-2SS	Medium for P200-2AM P200-2SM PD-2AM PD-2SM	Long for P200-2AL P200-2SL PD-2AL
3.0	PDS-2ECDMS-30	PDS-2ECDES-30	PDS-2ECDS-30	PDS-2ECDM-30	PDS-2ECDL-30
4.0	PDS-2ECDMS-40	PDS-2ECDES-40	PDS-2ECDS-40	PDS-2ECDM-40	PDS-2ECDL-40
5.0	PDS-2ECDMS-50	PDS-2ECDES-50	PDS-2ECDS-50	PDS-2ECDM-50	PDS-2ECDL-50
6.0	PDS-2ECDMS-60	PDS-2ECDES-60	PDS-2ECDS-60	PDS-2ECDM-60	PDS-2ECDL-60
7.0	PDS-2ECDMS-70	—	—	—	—

Super Coarse Diamond Burs

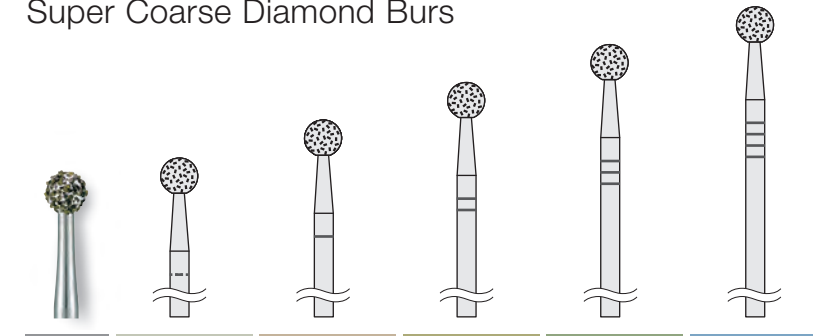

Head Size	MS for P200-2AMS P200-2SMS	Extra Short for P200-2AES P200-2SES PD-2AES PD-2SES	Short for P200-2AS P200-2SS PD-2AS PD-2SS	Medium for P200-2AM P200-2SM PD-2AM PD-2SM	Long for P200-2AL P200-2SL PD-2AL
3.0	PDS-2SCDMS-30	PDS-2SCDES-30	PDS-2SCDS-30	PDS-2SCDM-30	PDS-2SCDL-30
4.0	PDS-2SCDMS-40	PDS-2SCDES-40	PDS-2SCDS-40	PDS-2SCDM-40	PDS-2SCDL-40
5.0	PDS-2SCDMS-50	PDS-2SCDES-50	PDS-2SCDS-50	PDS-2SCDM-50	PDS-2SCDL-50
6.0	PDS-2SCDMS-60	PDS-2SCDES-60	PDS-2SCDS-60	PDS-2SCDM-60	PDS-2SCDL-60



ROTARY INSTRUMENTS $\varnothing 2.35$ mm

Neuro Burs

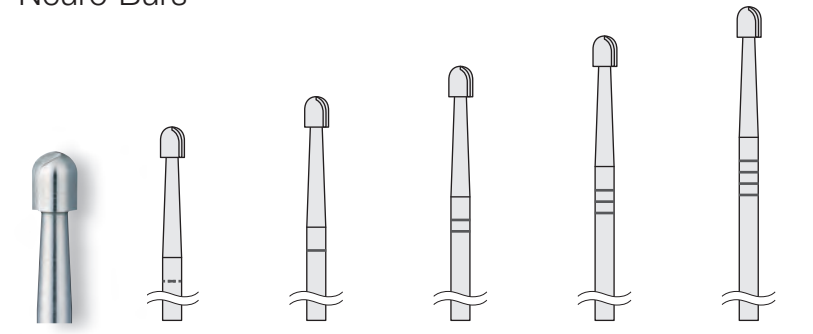

Head Size	MS	Extra Short	Short	Medium	Long
	for P200-2AMS P200-2SMS	for P200-2AES P200-2SES PD-2AES PD-2SES	for P200-2AS P200-2SS PD-2AS PD-2SS	for P200-2AM P200-2SM PD-2AM PD-2SM	for P200-2AL P200-2SL PD-2AL
1.8	PDS-2NMS-18	PDS-2NES-18	PDS-2NS-18	PDS-2NM-18	PDS-2NL-18
2.2	PDS-2NMS-22	PDS-2NES-22	PDS-2NS-22	PDS-2NM-22	PDS-2NL-22
3.0	PDS-2NMS-30	PDS-2NES-30	PDS-2NS-30	PDS-2NM-30	PDS-2NL-30

Neuro Carbide Burs

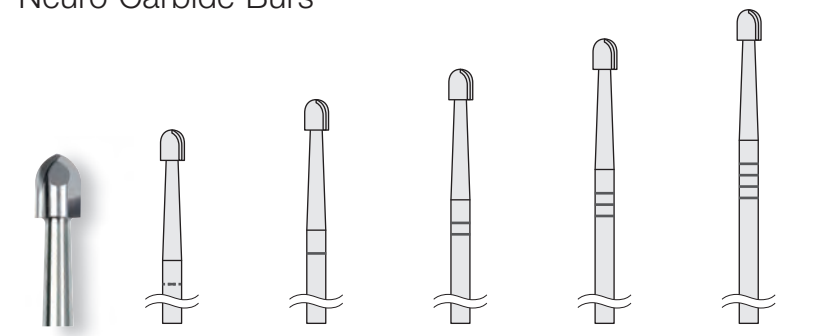

Head Size	MS	Extra Short	Short	Medium	Long
	for P200-2AMS P200-2SMS	for P200-2AES P200-2SES PD-2AES PD-2SES	for P200-2AS P200-2SS PD-2AS PD-2SS	for P200-2AM P200-2SM PD-2AM PD-2SM	for P200-2AL P200-2SL PD-2AL
1.8	PDS-2NCBMS-18	PDS-2NCBES-18	PDS-2NCBS-18	PDS-2NCBM-18	PDS-2NCBL-18
2.2	PDS-2NCBMS-22	PDS-2NCBES-22	PDS-2NCBS-22	PDS-2NCBM-22	PDS-2NCBL-22
3.0	PDS-2NCBMS-30	PDS-2NCBES-30	PDS-2NCBS-30	PDS-2NCBM-30	PDS-2NCBL-30



ROTARY INSTRUMENTS $\varnothing 2.35$ mm

Egg Burs

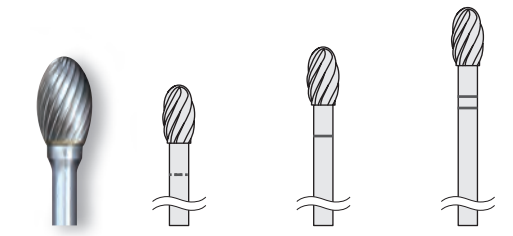

Head Size	MS	Extra Short	Short
	for P200-2AMS P200-2SMS	for P200-2AES P200-2SES PD-2AES PD-2SES	for P200-2AS P200-2SS PD-2AS PD-2SS
4.0	PDS-2EMS-40	PDS-2EES-40	PDS-2ES-40
6.0	PDS-2EMS-60	PDS-2EES-60	PDS-2ES-60

Barrel Burs

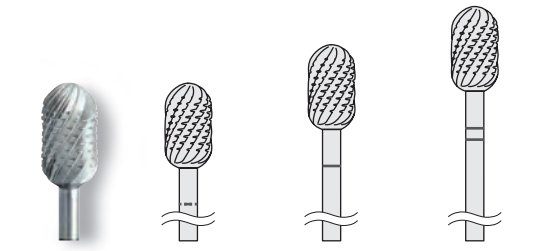

Head Size	MS	Extra Short	Short
	for P200-2AMS P200-2SMS	for P200-2AES P200-2SES PD-2AES PD-2SES	for P200-2AS P200-2SS PD-2AS PD-2SS
4.0	PDS-2BMS-40	PDS-2BES-40	PDS-2BS-40
6.0	PDS-2BMS-60	PDS-2BES-60	PDS-2BS-60

Pear Burs

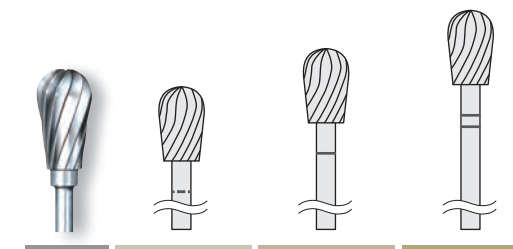

Head Size	MS	Extra Short	Short
	for P200-2AMS P200-2SMS	for P200-2AES P200-2SES PD-2AES PD-2SES	for P200-2AS P200-2SS PD-2AS PD-2SS
6.0	PDS-2PMS-60	PDS-2PES-60	PDS-2PS-60



ROTARY INSTRUMENTS $\varnothing 2.35$ mm

Lindemann Burs

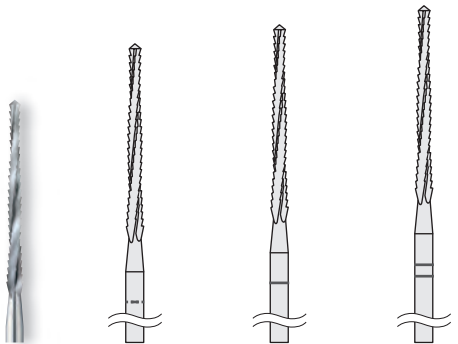

Length, Head Size	MS	Extra Short	Short
	for P200-2AMS P200-2SMS	for P200-2AES P200-2SES PD-2AES PD-2SES	for P200-2AS P200-2SS PD-2AS PD-2SS
11 x 2.1	PDS-2LMS-11	PDS-2LES-11	PDS-2LS-11
26 x 2.3	PDS-2LMS-26	PDS-2LES-26	PDS-2LS-26

Fissure Burs

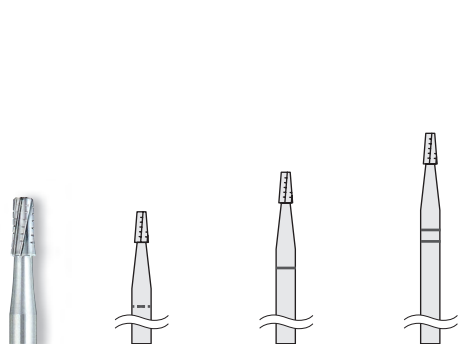

Head Size	MS	Extra Short	Short
	for P200-2AMS P200-2SMS	for P200-2AES P200-2SES PD-2AES PD-2SES	for P200-2AS P200-2SS PD-2AS PD-2SS
1.2	PDS-2FMS-12	PDS-2FES-12	PDS-2FS-12
1.6	PDS-2FMS-16	PDS-2FES-16	PDS-2FS-16
2.1	PDS-2FMS-21	PDS-2FES-21	PDS-2FS-21

Acorn Burs

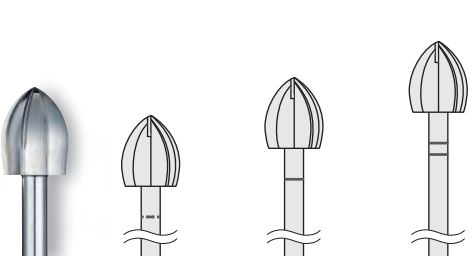

Head Size	MS	Extra Short	Short
	for P200-2AMS P200-2SMS	for P200-2AES P200-2SES PD-2AES PD-2SES	for P200-2AS P200-2SS PD-2AS PD-2SS
5.0	PDS-2AMS-50	PDS-2AES-50	PDS-2AS-50
6.0	PDS-2AMS-60	PDS-2AES-60	PDS-2AS-60
7.5	PDS-2AMS-75	PDS-2AES-75	PDS-2AS-75

Router Burs

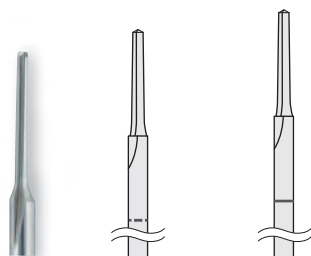

Head Size	MS	Extra Short
	for P200-2AMS P200-2SMS	for P200-2AES P200-2SES PD-2AES PD-2SES
1.3	PDS-2RMS-13	PDS-2RES-13

P200-2AMS MS
P200-2AES ES
P200-2AS S

P200-2SMS MS
P200-2SES ES
P200-2SS S

PD-2AES ES
PD-2AS S

PD-2SES ES
PD-2SS S

ROTARY INSTRUMENTS $\varnothing 3.17$ mm

Wirepass Drills

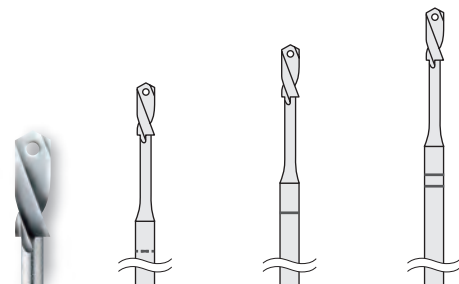

Head Size	MS	Extra Short	Short
	for P200-2AMS P200-2SMS	for P200-2AES P200-2SES PD-2AES PD-2SES	for P200-2AS P200-2SS PD-2AS PD-2SS
1.0	PDS-2WMS-10	PDS-2WES-10	PDS-2WS-10
1.2	PDS-2WMS-12	PDS-2WES-12	PDS-2WS-12
1.5	PDS-2WMS-15	PDS-2WES-15	PDS-2WS-15

P200-2AMS MS
P200-2AES ES
P200-2AS S

P200-2SMS MS
P200-2SES ES
P200-2SS S

PD-2AES ES
PD-2AS S

PD-2SES ES
PD-2SS S

Twist Drill Flat Tail

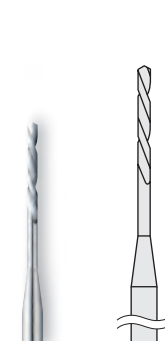

Head Size	MS
	for P200-2SD PD-2SD PD-2AD
1.0	PDS-2TD-10
1.5	PDS-2TD-15
2.0	PDS-2TD-20

P200-2SD

PD-2SD

PD-2AD

ROTARY INSTRUMENTS $\varnothing 3.17$ mm

Craniotome Handpiece Burs

Pediatric	Medium	Long
for P200-CRD-P PD-CRD-P	for P200-CRD-M PD-CRD-M	for P200-CRD-L PD-CRD-L
PDS-CRA-P	PDS-CRA-M	PDS-CRA-L

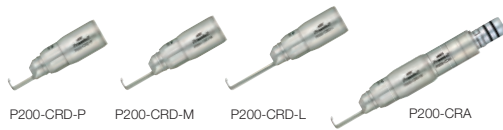

Router Burs

Pediatric	Medium	Long
for P200-CRD-P PD-CRD-P	for P200-CRD-M PD-CRD-M	for P200-CRD-L PD-CRD-L
PDS-ROU-P	PDS-ROU-M	PDS-ROU-L

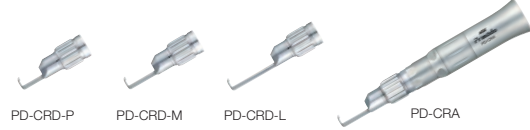

Round Fluted Burs

Head Size	Short for P200-3GAS	Medium for P200-3GAM	Long for P200-3GAL
1.0	PDS-3CS-10	PDS-3CM-10	—
2.0	PDS-3CS-20	PDS-3CM-20	PDS-3CL-20
3.0	PDS-3CS-30	PDS-3CM-30	PDS-3CL-30
4.0	PDS-3CS-40	PDS-3CM-40	PDS-3CL-40
5.0	PDS-3CS-50	PDS-3CM-50	PDS-3CL-50
6.0	PDS-3CS-60	PDS-3CM-60	PDS-3CL-60
7.0	PDS-3CS-70	PDS-3CM-70	PDS-3CL-70



ROTARY INSTRUMENTS $\varnothing 3.17$ mm

Diamond Burs

Head Size	Short for P200-3GAS	Medium for P200-3GAM	Medium [Extended] for P200-3GAM	Long for P200-3GAL	Long [Extended] for P200-3GAL
1.0	PDS-3DS-10	PDS-3DM-10	—	—	—
2.0	PDS-3DS-20	PDS-3DM-20	PDS-3DM-20E	PDS-3DL-20	PDS-3DL-20E
3.0	PDS-3DS-30	PDS-3DM-30	—	PDS-3DL-30	—
4.0	PDS-3DS-40	PDS-3DM-40	—	PDS-3DL-40	—
5.0	PDS-3DS-50	PDS-3DM-50	—	PDS-3DL-50	—
6.0	PDS-3DS-60	PDS-3DM-60	—	PDS-3DL-60	—
7.0	PDS-3DS-70	PDS-3DM-70	—	PDS-3DL-70	—

Extended bur: Burs can be extended by 10 mm from the original length.

Coarse Diamond Burs

Head Size	Short for P200-3GAS	Medium for P200-3GAM	Medium [Extended] for P200-3GAM	Long for P200-3GAL	Long [Extended] for P200-3GAL
2.0	PDS-3CDS-20	PDS-3CDM-20	—	PDS-3CDL-20	—
3.0	PDS-3CDS-30	PDS-3CDM-30	PDS-3CDM-30E	PDS-3CDL-30	PDS-3CDL-30E
4.0	PDS-3CDS-40	PDS-3CDM-40	PDS-3CDM-40E	PDS-3CDL-40	PDS-3CDL-40E
5.0	PDS-3CDS-50	PDS-3CDM-50	PDS-3CDM-50E	PDS-3CDL-50	PDS-3CDL-50E
6.0	PDS-3CDS-60	PDS-3CDM-60	—	PDS-3CDL-60	—
7.0	PDS-3CDS-70	PDS-3CDM-70	—	PDS-3CDL-70	—

Extended bur: Burs can be extended by 10 mm from the original length.



ROTARY INSTRUMENTS $\varnothing 3.17$ mm

Neuro Burs

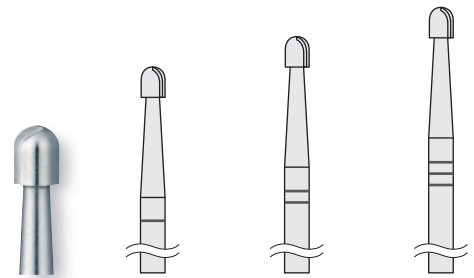

Head Size	Short	Medium	Long
	for P200-3GAS	for P200-3GAM	for P200-3GAL
1.8	PDS-3NS-18	PDS-3NM-18	PDS-3NL-18
2.2	PDS-3NS-22	PDS-3NM-22	PDS-3NL-22
3.0	PDS-3NS-30	PDS-3NM-30	PDS-3NL-30



ROTARY INSTRUMENTS $\varnothing 3.17$ mm

Acorn Burs

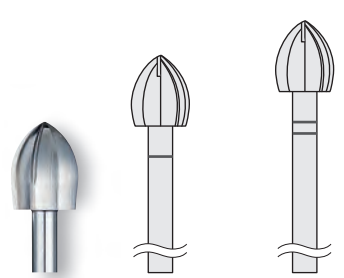

Head Size	Short	Medium
	for P200-3GAS	for P200-3GAM
7.5	PDS-3AS-75	PDS-3AM-75
9.0	PDS-3AS-90	PDS-3AM-90



Cylinder Burs

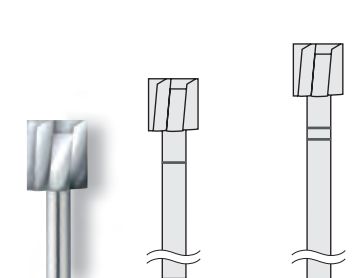

Head Size	Short	Medium
	for P200-3GAS	for P200-3GAM
6.0	PDS-3BS-60	PDS-3BM-60
9.1	PDS-3BS-91	PDS-3BM-91

Metal Cutting Carbide Bur



Head Size	for P200-3MC
1.6	PDS-3MCS-CB16
3.0	PDS-3MCS-CB30



Metal Cutting Diamond Disc

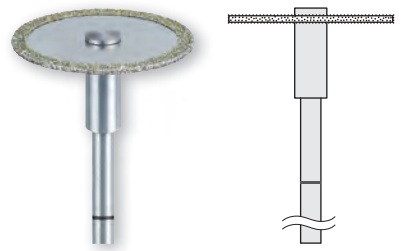

Head Size	for P200-3MC
25.4	PDS-3MCS-DD254

SAW BLADES

Sagittal and Oscillating Saw Blades Scale : 1/1

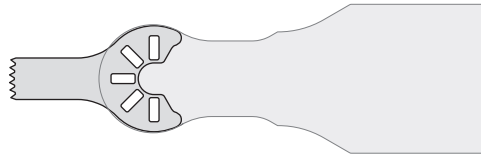

order code
PDS-SO-411
• Thickness : 0.4 mm

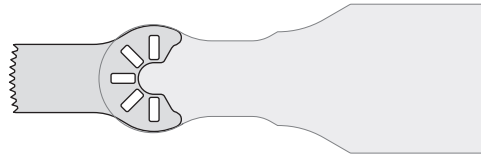

order code
PDS-SO-412
• Thickness : 0.4 mm

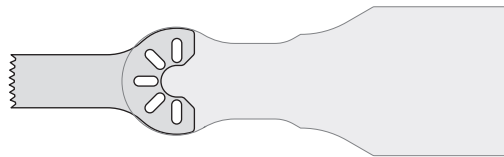

order code
PDS-SO-422
• Thickness : 0.4 mm

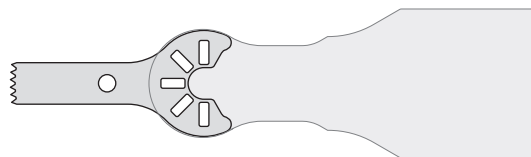

order code
PDS-SO-431
• Thickness : 0.4 mm

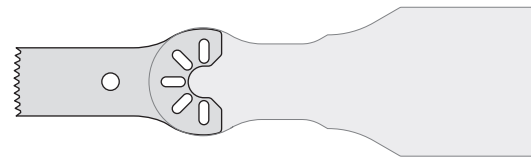

order code
PDS-SO-432
• Thickness : 0.4 mm

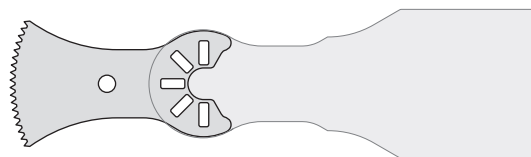

order code
PDS-SO-433
• Thickness : 0.4 mm

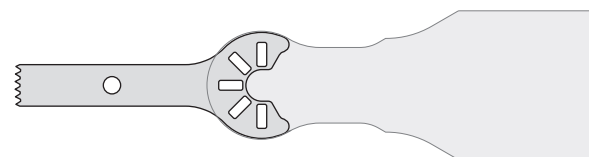

order code
PDS-SO-441
• Thickness : 0.4 mm



P200-SAG

P200-OSC

PD-SA-S

SAW BLADES

Sagittal and Oscillating Saw Blades Scale : 1/1

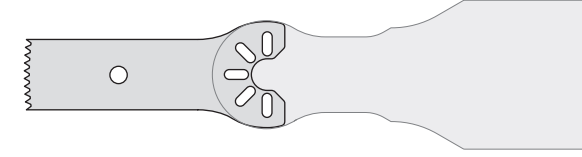

order code
PDS-SO-442
• Thickness : 0.4 mm

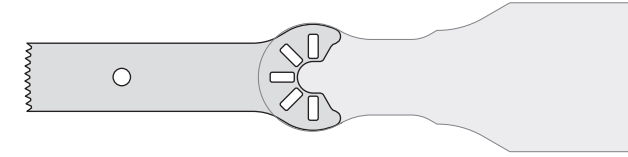

order code
PDS-SO-452
• Thickness : 0.4 mm

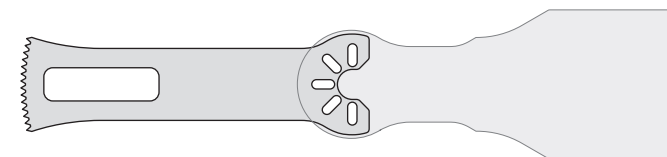

order code
PDS-SO-453
• Thickness : 0.4 mm

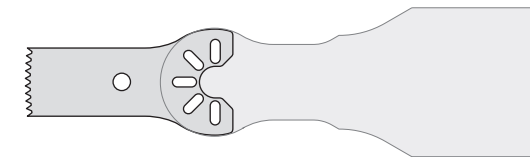

order code
PDS-SO-632
• Thickness : 0.6 mm

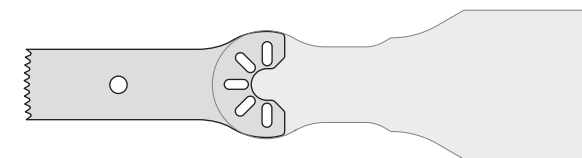

order code
PDS-SO-642
• Thickness : 0.6 mm

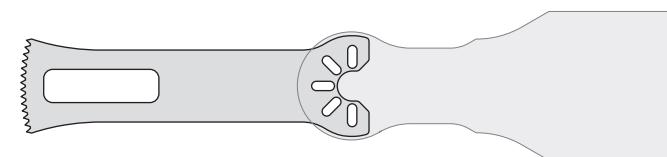

order code
PDS-SO-653
• Thickness : 0.6 mm



P200-SAG

P200-OSC

PD-SA-S

INTRA ORAL BLADES

Oscillating Saw Blades (for Intra Oral) Scale : 1/1

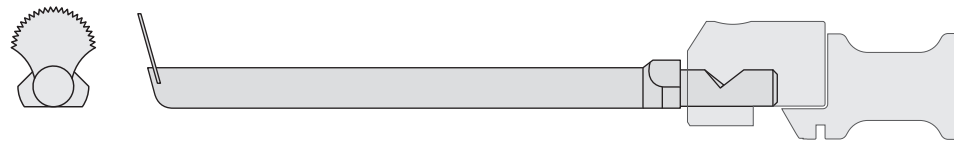

order code
PDS-OSC-422
• Thickness : 0.4 mm

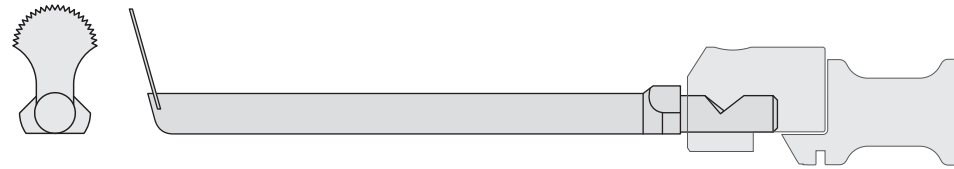

order code
PDS-OSC-432
• Thickness : 0.4 mm



order code
PD-OSC-A
Adaptor
• For Oscillating Intra Oral Blades
• Bundled Item: Corresponding wrench (1), and screws (2)

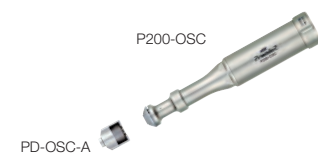

SAW BLADES

Reciprocating Saw Blades Scale : 1/1

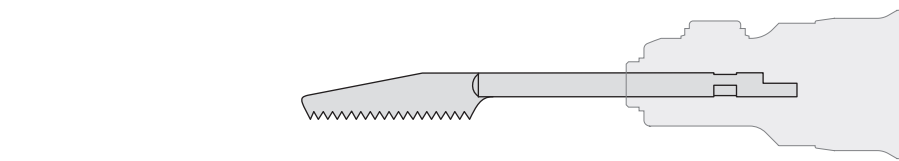

order code
PDS-RE-4023
• Thickness : 0.4 mm

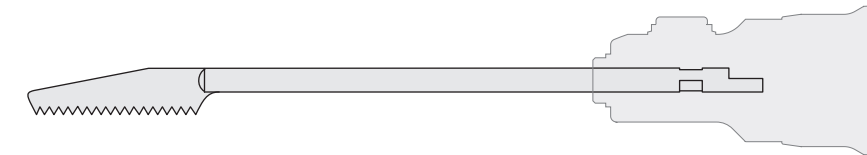

order code
PDS-RE-4023E
• Thickness : 0.4 mm

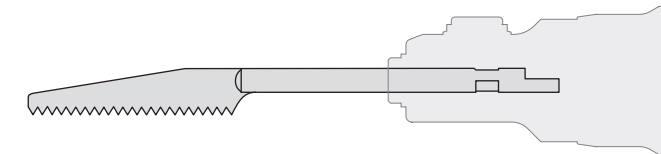

order code
PDS-RE-4028
• Thickness : 0.4 mm

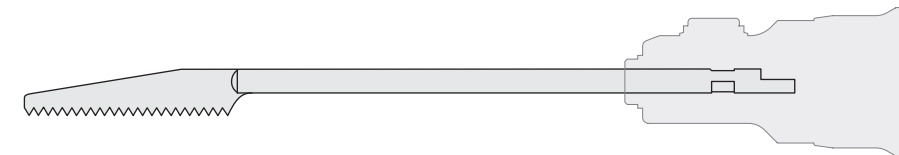

order code
PDS-RE-4028E
• Thickness : 0.4 mm



SAW BLADES

Reciprocating Saw Blades Scale : 1/1

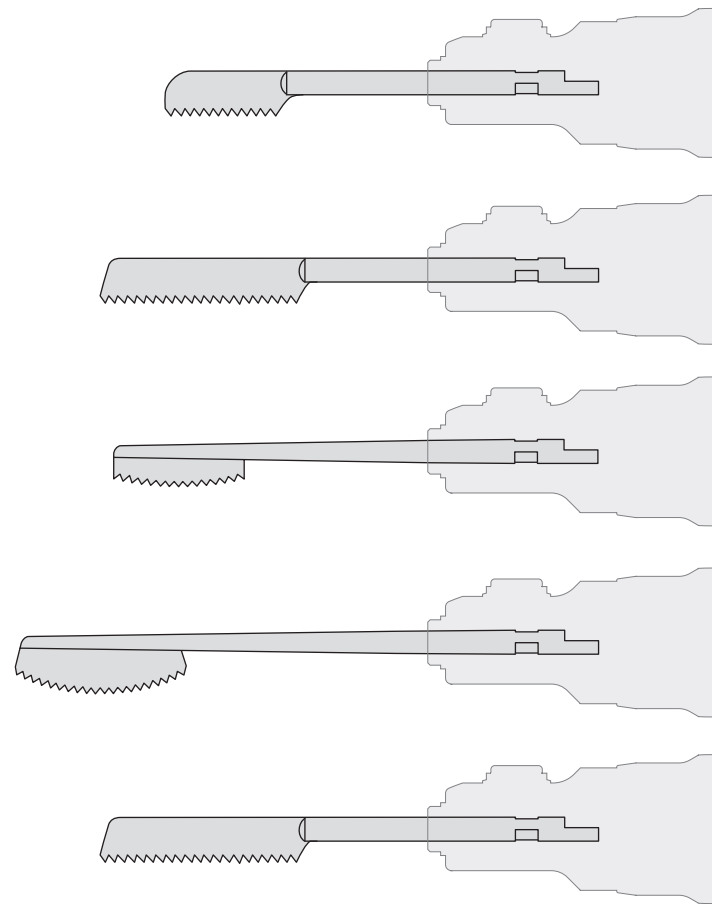

order code
PDS-RE-4114
• Thickness : 0.4 mm

order code
PDS-RE-4127
• Thickness : 0.4 mm

order code
PDS-RE-4217
• Thickness : 0.4 mm

order code
PDS-RE-4223
• Thickness : 0.4 mm

order code
PDS-RE-6127
• Thickness : 0.6 mm



RASPS

Reciprocating Rasps Scale : 1/1

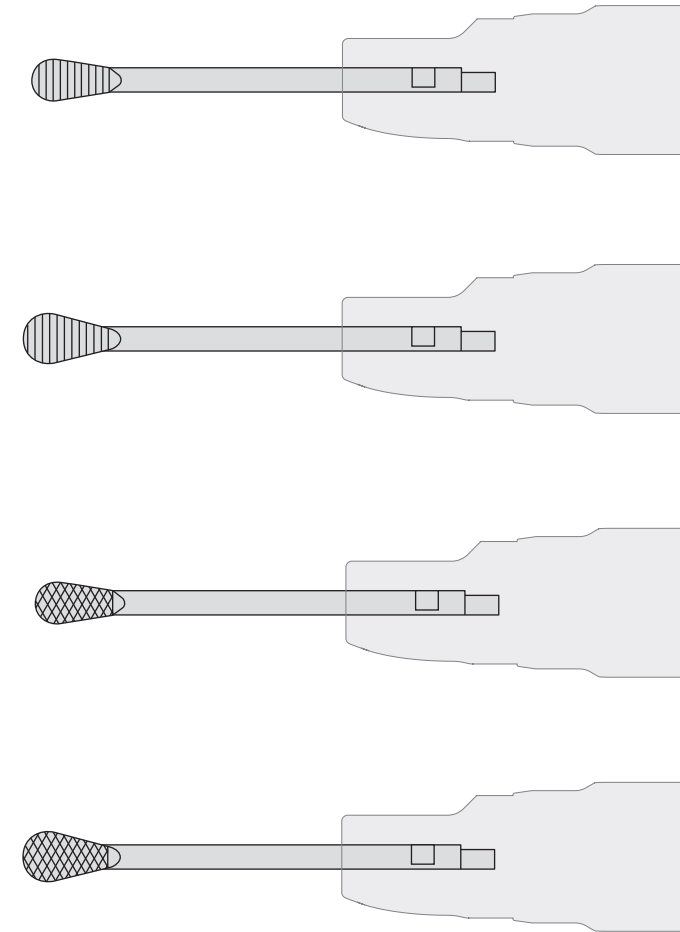

order code
PDS-RE-R011
• Straight

order code
PDS-RE-R012
• Straight

order code
PDS-RE-R111
• Cross-Cut

order code
PDS-RE-R112
• Cross-Cut



MEMO

Manufacturer

NAKANISHI INC. www.nsk-surgery.com

700 Shimohinata, Kanuma, Tochigi 322-8666, Japan
TEL : +81 (0)289-64-3380 FAX : +81 (0)289-64-3890

NSK America Corp

1800 Global Parkway, Hoffman Estates, IL 60192, USA
TEL : +1 888 675 1675 FAX : +1 800 838 9328

Specifications are subject to change without notice. Burs / Blades / Rasps are sterilized. Burs / Blades / Rasps are "Single Use" only.